

CR 340

$1\frac{1}{16}$ x $3\frac{7}{16}$

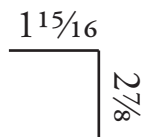

American Victorian

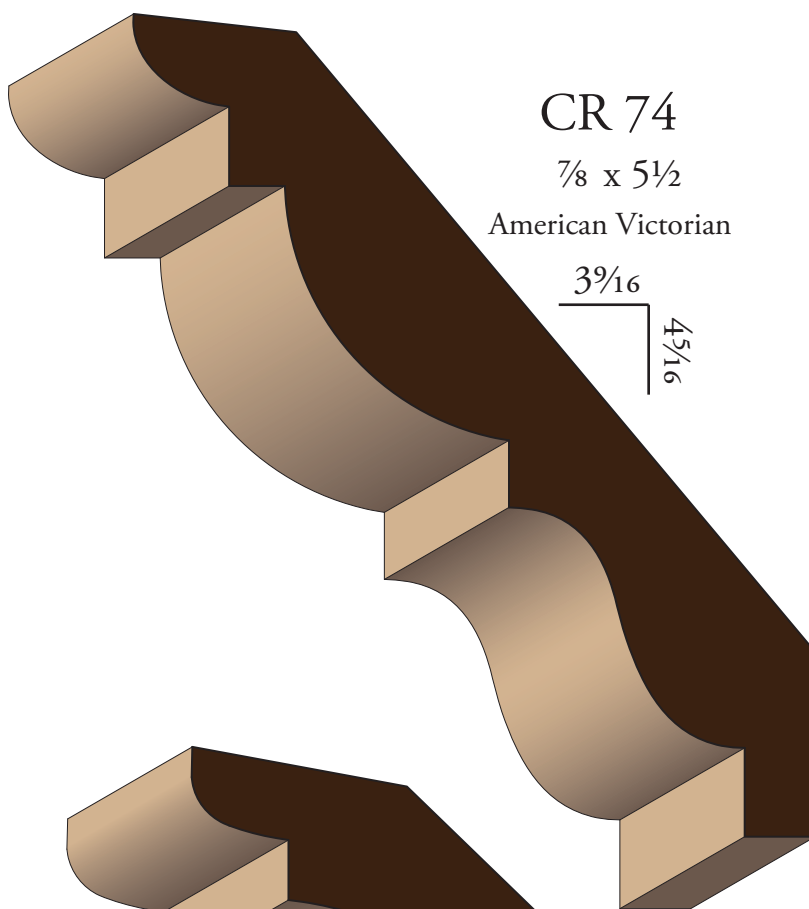

CR 74

$\frac{7}{8}$ x $5\frac{1}{2}$

American Victorian

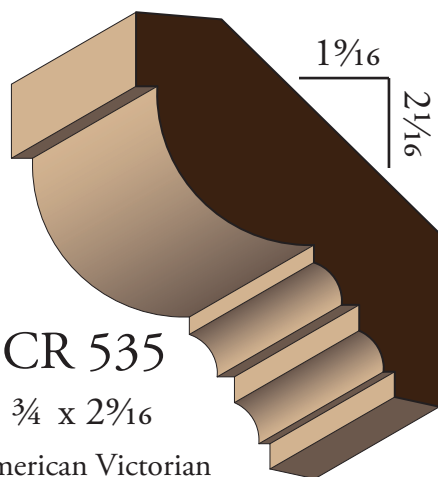
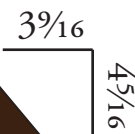

CR 535

$\frac{3}{4}$ x $2\frac{9}{16}$

American Victorian

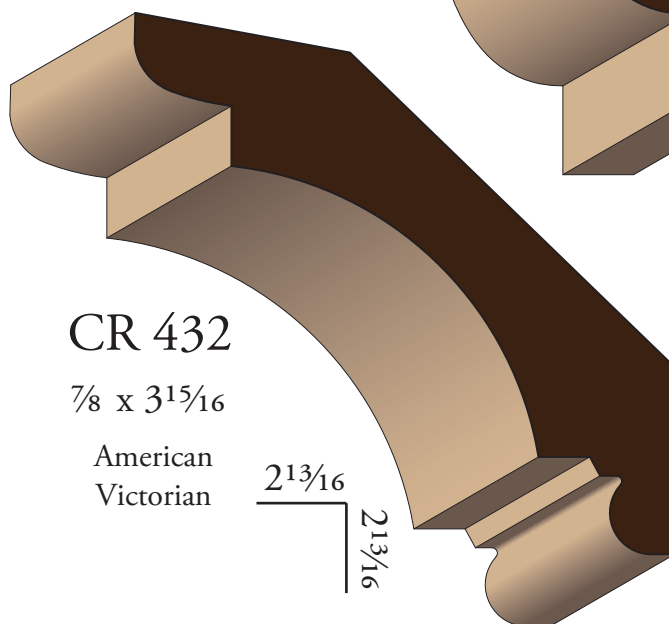

CR 432

$\frac{7}{8}$ x $3\frac{15}{16}$

American
Victorian

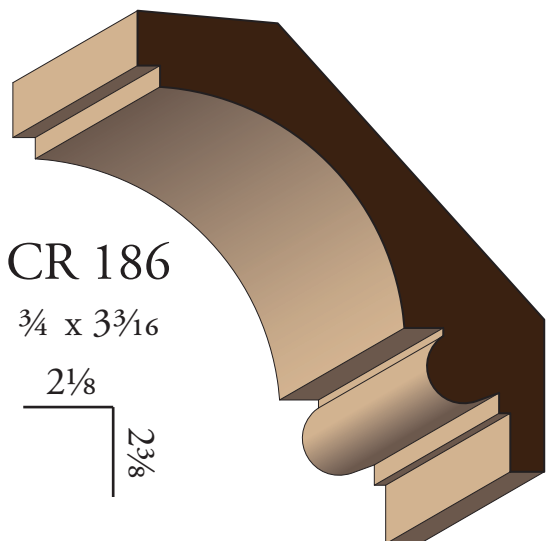
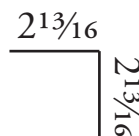

CR 186

$\frac{3}{4}$ x $3\frac{3}{16}$

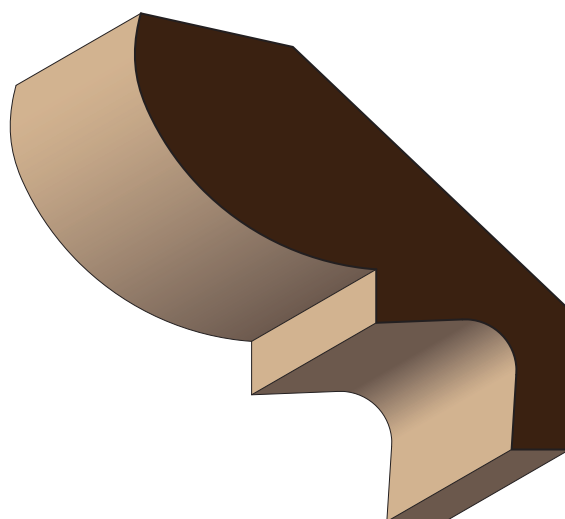
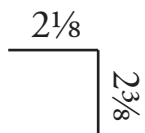

CR 78

$\frac{7}{8}$ x $3\frac{3}{16}$

American Victorian

